



F740

Manual

F740
User manual

Index

Introduction	6
Sales package contents	7
Precautions for use	8
Overview	12
Installation	14
Keyboard.....	18
Numeric keypad	21
Display	22
System icons	23
Widget.....	24
Applications menu	26
Settings	30
Calling	33
Messages.....	37
Contacts	41
Bluetooth®connection	45
Troubleshooting.....	46
Regulation	49

Introduction

Thank you for choosing Co-Comm F740 device. This phone is designed for being used with GSM 900/1800, UMTS 900/2100 MHz, LTE FDD B1/2100MHz, B3/1800MHz, B7/2600MHz, B20/800MHz and LTE TDD B38/2600MHz networks and for operation requires a valid SIM card from your network operator. Please consult your network operator for more information.

Security instructions

Please read following instructions carefully before you start using your Co-Comm F740 telephone:

- Keep this manual for future reference.
- Keep the phone away from moisture.
- Place the phone on a stable surface before start using.
- If any of the following situations occurs, have it checked by a qualified service technician:
 - It has been exposed to moisture.
 - It has been dropped or damaged.
 - It has obvious signs of breakage.
- Do not place the phone at a distance of less than 1.5 m from a water source.
- Do not use the device in areas where there is risk of explosion.

Sales package contents

Please check the sales package includes following components. If any items are missing, please contact your dealer.



1. Co-Comm F740 wireless phone



2. User manual



3. Guarantee card



4. AC/DC power adapter



5. Li-Po rechargeable battery



6. Security screw, key and QC PASS sticker



7. USB data cable

Precautions for use

Operating Environment

Your Co-Comm F740 phone is a RF transmitter, so please turn off your terminal or disable radio functions within following situations:

- When you are in an airplane.
- When you are in the vicinity of flammable atmospheres and is indicated by the entity responsible for risk management.
- When you are in the vicinity of electro-explosive devices and is indicated by the entity responsible for risk management.

Respect special regulations in force in any area, and always switch off your phone when its use is prohibited, or if it could cause danger. When connecting the phone or any accessory to another device, read user manual for detailed safety instructions. Do not connect incompatible products. It is recommended that the equipment should only be used in normal position for proper operation and personnel safety. Do not expose to temperatures below -10 °C or above 50 °C.

Medical equipment

Be sure to turn off the phone near electronic medical equipment which obviously require that the phone is turned off (such as pacemakers, hearing aids, etc.).

Most medical devices can be protected from RF signal of the phone, but not all of them. If you have any questions or need more information, consult your doctor or manufacturer of your medical device.

Auditive Protection



This phone complies with current regulations to limit the maximum output volume. Using headphones at very high volume may cause hearing damage.

Precautions for use

- Turn down the volume or stop using the product if your ears are ringing.
- Do not raise the volume too much, doctors warn against the prolonged exposition to high volume.
- Excessive acoustic pressure from headphones can cause hearing loss.
- To prevent possible hearing damage, do not listen for long period at high volume.

Pacemakers

Pacemaker manufacturers warn that distance between phone and heart pacemaker must be at least 6 inches (15.3 cm).

People with pacemakers should consider the following:

- Always keep a distance (at least 6 inches) between phone and pacemaker when phone is on.
- Do not carry your phone near your chest.
- Use the phone with the opposite ear from the pacemaker.

Please turn off your phone if you feel there is interference, consult your doctor as soon as possible.

Emergency calls

Like any mobile phone, this device works with radio signals that can not guarantee connection in all conditions. Therefore, you should never rely solely on a mobile phone for essential communications like medical emergencies. To make or receive calls, phone must be switched on and in a service area with adequate signal strength. To make an emergency call, enter local emergency number in standby mode and press call button.

Precautions for use

Care and maintenance

Your phone is a product of high technology and should be treated with care. Following tips will allow you to enjoy this product for a longer period of time:

- **Do not** keep the phone away from children and pets. They could damage it accidentally or choke on small parts.
- **Do not** keep the phone dry and avoid liquids that could corrode it. Do not use the phone with wet hands, which may cause electric shock.
- **Do not** place the phone in areas of excessive heat, which shorten its life cycle, damage batteries, or melt accessories.
- **Do not** place the phone in cold areas. When phone warms up to its normal operating temperature, moisture can accumulate, which may damage electronic circuits.
- **Do not** place the phone in areas exposed to sunlight as it may cause overheating.
- **Do not** place the phone near flammable liquids, gases or explosive substances.
- **Do not** drop or knock the phone. Rough handling can damage electronic circuits.
- **Do not** clean the telephone, use a damp or antistatic cloth. Do not use a dry or static cloth.
- **Do not** use chemicals such as cleaning solvents to clean phone surface. Turn off your phone before cleaning.
- **Do not** apply paint over the phone, as it can prevent proper operation.
- **The manufacturer's warranty does not cover repair appliance if the phone or battery gets wet, or phone label is damaged even when phone warranty has not expired.**

Precautions for use

Battery use

- Never use any charger or battery if damaged. Use the battery correctly.
- Do not short-circuit the battery, as this may damage it or cause a fire.
- Do not subject the battery to high temperatures or fire as it may explode.
- Return old battery to your dealer, or place it in locations designated for recycling.
- Do not throw the battery in household waste.
- Charging time depends on the remaining battery charge, type of battery and charger used.
- Battery can be charged and discharged hundreds of times, but its duration will gradually decrease.
- When operation time is noticeably shorter than normal, replace the battery with a new one.
- Use only original chargers, batteries and accessories approved by the manufacturer.
- Disconnect the charger from the electrical plug and the device when the phone is not in use.
- Do not overload your battery as it may damage or shorten its life.
- Do not expose the battery to places of extremely hot or cold temperatures, as it will reduce battery capacity.
- Lithium-ion batteries are particularly affected by temperatures below 0° C.

Overview

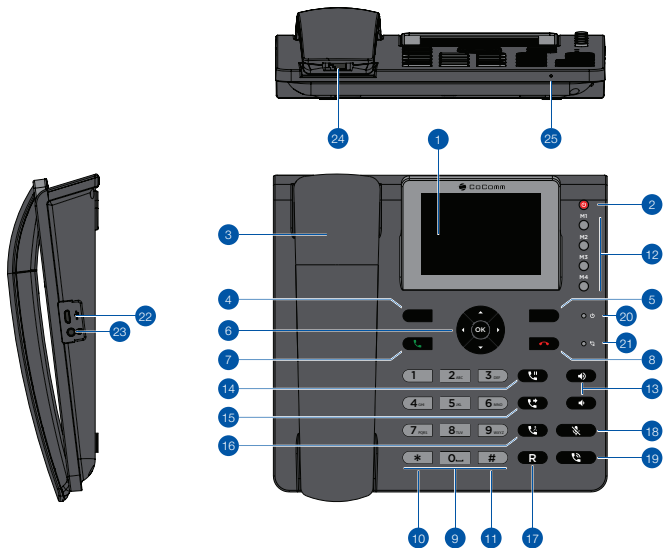

1. LCD screen
2. [] Turn on / off
3. Handset / receiver
4. [-] Menu left soft key
5. [-] Menu right soft key
6. Direction and confirmation buttons
7. [] Call key
8. [] End call key / back to main menu
9. Alphanumeric keypad
10. [*] Asterisk key
11. [#] Hash key
12. [**M1...M4**] Speed dial keys M1 to M8
13. [< / >] Volume keys
14. [] Hold key
15. [] Transfer key
16. [] Multi-conference key
17. [**R**] Redial key
18. [] Mute key
19. [] Hands-free key

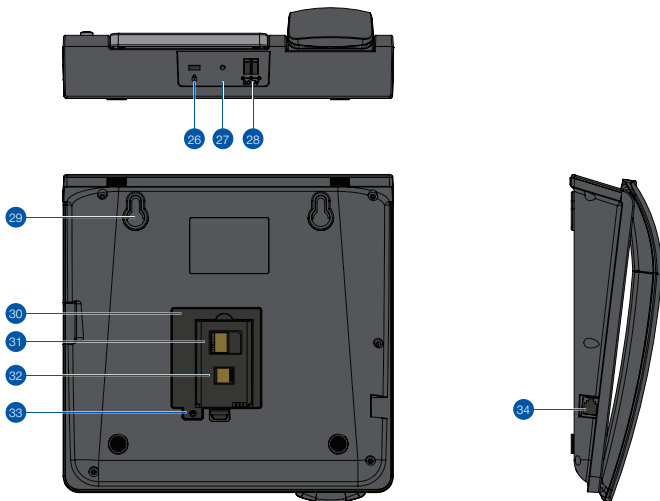

- 20. Charging indicator
- 21. Hands-free indicator
- 22. Micro-USB data port for software update
- 23. Jack connector for earphones / handsfree
- 24. Handset RJ9 connector
- 25. Microphone for handsfree function
- 26. Anti-theft cable slot
- 27. Microphone for ambient noise cancelling

- 28. DC 5V power connector
- 29. Wall mounting holes
- 30. Rechargeable battery compartment
- 31. SIM card compartment
- 32. Micro-SD card compartment
- 33. Hole for security screw
- 34. Receiver RJ9 connector

Installation

Follow below steps to install the SIM card and different accessories of your wireless phone Co-Comm F740:

1. Disconnect power adapter and remove battery cover compartment located behind the device to install the SIM card and the micro-SD memory card. To install the SIM card, slide the metal tab in the direction shown to unlock it, turn it up, and place the card as shown in the figure. Turn the metal tab down and slide to the initial position to lock.

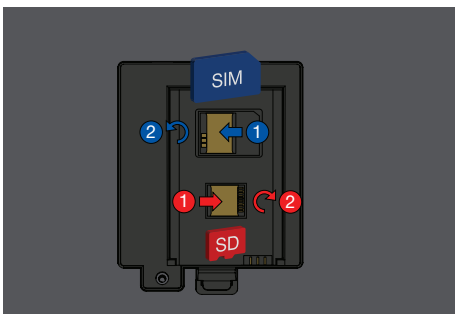

2. Follow same procedure if you want to install a micro-SD card, but this time, slide the metal tab in the opposite direction to unlock it, as shown in the figure. Place the memory card, and then turn down the metal tab and slide to the initial position to lock.

Installation

3. Insert the battery within dedicated compartment, making sure that connector electrodes on the terminal match the slots in the top of the battery as shown in the figure. Replace the lid of the battery compartment, making sure it is securely locked in place.



4. Close the lid of the battery compartment using the screw and supplied key, and use a QC PASS adhesive sticker to cover the screw hole.

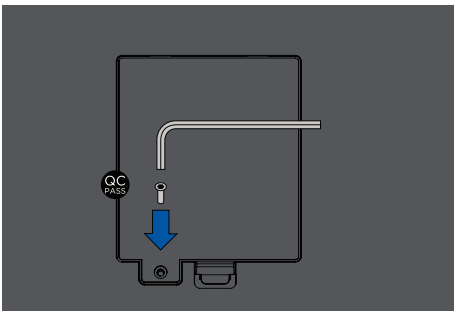

Installation

5. Conecte el cable rizado del auricular en la base del teléfono. Conecte uno de los extremos del cable al conector situado en el lateral izquierdo de la base del teléfono.

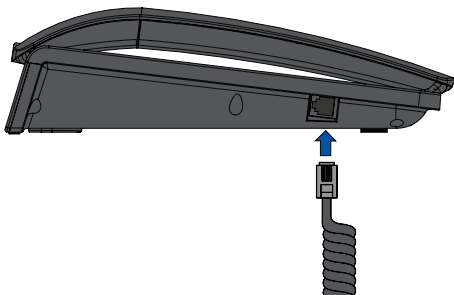

6. Conecte el otro extremo del cable rizado en la toma del auricular, tal como se indica en la ilustración.

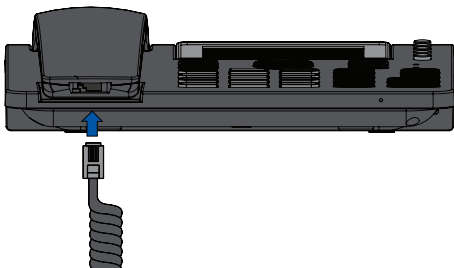

7. Connect power supply cable to the connector on the back of the phone and then plug the power supply into a household AC power outlet. Battery level will be displayed on the screen showing charging process status.

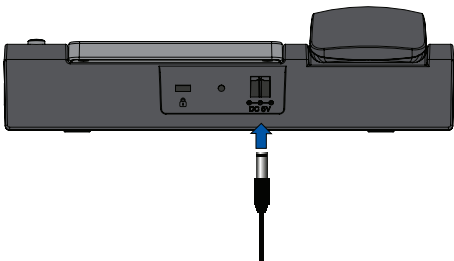











Battery Charge

When battery level is low, the phone will issue a warning tone and a low battery message. Connect power adapter into the device to start charging. Battery level is indicated on the screen during charging process, and once it is fully charged, battery icon will appear full. Charging a completely discharged battery can last 2 to 3 hours. Fully charge the battery before using the device for the first time.

Note:



Always make sure your device is turned off before removing your SIM card. This will prevent data loss and damage to the SIM card. Do not place SIM card near surfaces or electromagnetic environments and avoid touching metal connectors. For more information, contact your network operator.

Keyboard

Key	Function
[] Turn On/Off	When terminal is off, press for 3 seconds to turn on the phone. When terminal is on, press for 5 seconds to turn off the phone.
[][] Up/Down	Move the cursor up/down by accessing on-screen menu or submenus.
[][] Left/Right	Move the cursor left/right by accessing on-screen menu or submenus.
[] Confirmation	Confirm operations by accessing on-screen menu or submenu. In standby mode, press to access call log.
[][] Softkey	Use these keys to perform different actions indicated at the bottom of the on-screen menus.
[] Pick up	Press to dial an outgoing call or answer an incoming call.
[] Hang up	During an active call, press to end the call. In applications, press to return to main menu.
[1...9] Numeric pad	Press to enter numbers or characters.

Key	Function
[*] Asterisk key	Insert asterisk character.
[#] Hash key	Insert pad character. Change the text input method.
[M1-M4] Memory keys	Programmable keys to store up to four telephone numbers.
[Hold] Hold button	During an active call, press to hold current call. During two active calls, press to switch from Call 1 to Call 2.
[Transfer] Transfer button	When you have two calls, one active and one holded, press to make a call transfer between both calls. You can make a transfer "Without consultation," pressing when making the second call.
[Conf] Conference button	You can make conference calls from your phone, press during a call for 2 or more participants.
[R] Recall button	In standby mode, press to redial last number from last log.
[Decrease/Increase] Decrease / Increase volume	Press to decrease / increase the volume of handset or speaker.

Keyboard

Key	Function
[] Mute button	Press during an active call to mute your microphone.
[] Hands-free button	In standby, press to make a call in hands-free mode, without lifting the handset. During an active call, press to enable or disable phone hands-free mode.

Numeric keypad

Check the below table when using alphanumeric keypad. When introducing some form of text on your phone, you can switch between entering numbers (123), lower case (abc) or uppercase (ABC) by pressing the # key.

Key	Lowercase (abc)	Uppercase (ABC)
1	.,?!-@ 1	.,?!-@ 1
2	abc2	ABC2
3	def3	DEF3
4	ghi4	GHI4
5	jkl5	JKL5
6	mno6	MNO6
7	pqrs7	PQRS7
8	tuv8	TUV8
9	wxyz9	WXYZ9
0	[space] and 0	
#	Toggle among: Numbers / Lowercase / Uppercase / Default text	
*	Special character selection menu	

Display

Press the [] key for 3 seconds to turn on the terminal. The first time a SIM card is inserted the terminal will ask for a PIN code. Then, the following user interface will be shown on the screen.

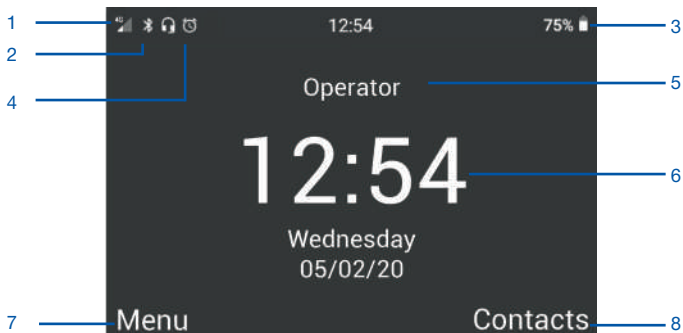























- | | |
|--|---|
| 1. 2G/3G/4G Coverage Indicator | 5. Network Operator |
| 2. System Notifications: SMS, calls, alarms, Bluetooth, etc. | 6. Time and Date |
| 3. Battery level Indicator | 7. Function assigned to the left softkey |
| 4. Status Indicators: microphone, handsfree, headset, etc. | 8. Function assigned to the right softkey |

Press [**OK**] to show on the screen the calls log, use the left selection key to access the application menu. You can also make a call from this interface, dialing the phone number directly on the numeric keypad.

To turn off the terminal, press [] for 5 seconds.

System icons

Following illustration explains the meaning of system main icons that can be displayed on your phone:

	Signal level		Notifications
	Data network connection		Status information
	No signal		No SIM card
	Message received		Low battery
	Call		Charging battery
	Call end		Microphone off
	Call transfer		Bluetooth active
	Hands-free		Bluetooth connected
	Call missed		USB connection
	Call hold		Headphones connected
	Alarm active		Headphones with mic

Widget

The main user interface changes when there are notifications or when an application is running in the background. In this case, the following user interface will appear on the device screen.

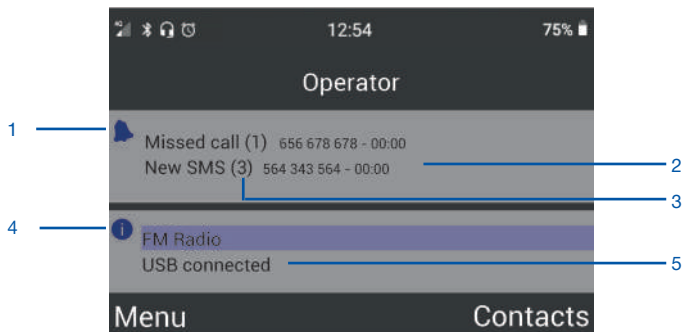

- | | |
|--|---|
| 1. Notification Bar: missed calls and new SMS | 3. Quantity of each notification |
| 2. Information about the notification: phone number and hour | 4. Status Information Bar |
| | 5. Applications running in the background |

Use the arrow keys [▲][▼] to move through each notification bar, and use these arrows keys [◀][▶] to switch from one to another. Press [OK] to select:

- Missed call: press [**OK**] to access the calls log.
- New SMS: press [**OK**] to access the Messages application.
- FM Radio: press [**OK**] to access the FM Radio application.
- USB connected: press [**OK**] to access the 'Use USB to' screen.
- Music: press [**OK**] to access the Music application.

Note:

The notification bar disappears where there is no notification. The status information bar disappears where there is no application running in the background.

Applications menu

Once the device is turned on and the configuration process is completed, the main menu will be shown on the screen. Press the left selection key to access the applications menu and the next user interface will be displayed on the screen.

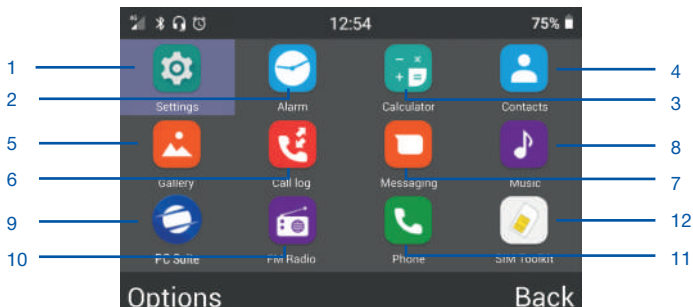

- | | |
|---------------|-----------------|
| 1. Settings | 7. Messaging |
| 2. Alarm | 8. Music |
| 3. Calculator | 9. PC Suite |
| 4. Contacts | 10. FM Radio |
| 5. Gallery | 11. Phone |
| 6. Call log | 12. SIM Toolkit |

Note:

It is not allowed to install any application on the device.

Applications menu

From the application menu you can also customize the main menu. Press the left selection key to display the available options:

- **Wallpapers:** choose the wallpaper of the main menu among the available backgrounds.
- **Softkeys:** select the application associated with the right soft key in the main menu.

Under the application menu, use the arrow keys [◀][▶][▲][▼] to select one of the icons, and press [OK] button to access the application.

Settings

Select the  icon from the applications menu, and press [OK] to access the system settings menu. Use the [▲][▼] arrow keys to select the network and Internet settings, the connected devices, the battery, the screen, etc., and press [OK] to access the configuration.

Alarm

Select the  icon from the applications menu, and press [OK] to access the alarm application. Press [OK] to activate or deactivate the selected alarm, or press the left softkey to edit, delete or add new alarms.

Calculator

Select the  icon from the applications menu, and press [OK] to access the calculator. Use the following keys on the right-hand side of the interface to perform the different arithmetic operations.

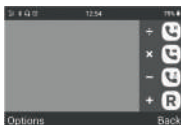

[÷]	Divide
[×]	Multiply
[−]	Subtract
[+]	Add
[=]	Equal to

Applications menu

Contacts

Select the  icon from the applications menu, and press [**OK**] to access the telephone contact list, press the left selection key to access the options to delete, add or import/export contacts

Gallery

Select the  icon from the applications menu, and press [**OK**] to access the image gallery. In this application, you will be able to see the image and video files stored on the phone memory or on its micro-SD card. Use the [**◀**] [**▶**] [**▲**] [**▼**] arrow keys to display folders and files, and press [**OK**] to play. Press the left softkey to access the options to delete files or share through messages or Bluetooth.

Call log

Select the  icon from the applications menu, and press [**OK**] to access the calls log. From that menu, you can see the made, received or missed calls.

Messages

Select the  icon from the applications menu, and press [**OK**] to access the telephone's message application. In this application, you can write and send SMS text and MMS multimedia messages, as well as look at the received ones.

Music

Select the  icon from the applications menu, and press [**OK**] to access the audio player. Use the [**◀**] [**▶**] arrow keys to select the classification mode, and use the [**▲**] [**▼**] arrow keys to select a file. Press [**OK**] to begin the playback, or press the left softkey for the audio options, like deleting files.

Applications menu

PC Suite

Your Co-Comm F740 terminal has a PC application that allows you to manage your calls, messages, contacts, and so on, easily from your personal computer. You can download the PC application for your Co-Comm F740 in the PC Suite section of this Web site <http://www.cocomm.es>.

Install and execute the downloaded application on your personal computer. Select the  icon from the applications menu on the telephone, and press [OK] to access PC Suite mode. Connect the USB cable between your terminal and your PC, then press Options and select Activate PC Suite in the pop-up menu to connect your Co-Comm F740 to the installed application on your PC.

FM Radio

Select the  icon from the applications menu, and press [OK] to access the FM Radio application. Use the [◀] [▶] arrow keys to select the search mode, manual (◀ ▶) or automatic (⏪⏩), then press [OK] to search for radio stations.

Telephone

Select the  icon from the applications menu, and press [OK] to access the calls menu. From that menu, you can make calls to a contact, dial a phone number or send text messages. You can also assign phone numbers to the speed dial keys [M1-M4], as well as to buttons from the numeric keypad [1...9]. Press the left softkey to display the options menu and follow the instructions displayed on the screen.

Settings

NETWORK

- └ Mobile network
- └ Data usage
- └ Hotspot & tethering
- └ VPN
- └ Airplane mode

CONNECTED DEVICES

- └ Bluetooth
- └ USB

APPS & NOTIFICATIONS

- └ Recently opened apps
- └ Notifications
- └ App permissions
- └ Advanced
 - └ Default apps
 - └ Special app access

BATTERY

- └ Standby intelligent power saving
- └ Battery saver
- └ Battery percentage
- └ Sleep

DISPLAY

- └ Brightness level
- └ Wallpaper
- └ Sleep
- └ Font size
- └ Advanced
 - └ Display size
 - └ Screen saver

Settings

SOUND

- └ Media volume
- └ Do not disturb preferences
- └ Phone ringtone
- └ Advanced
 - └ Default notification sound
 - └ Default alarm sound
 - └ Other sounds

STORAGE

SECURITY



- └ Show passwords
- └ SIM card lock

SYSTEM







- └ Language & input
- └ Date & time
- └ Reset options
- └ About phone

There are different methods to make a call from your Co-Comm F740 terminal:





Calling using alphanumeric keypad

1. In standby mode pick up the handset, dial the phone number using the alphanumeric keypad and press the  key to make the call.
2. To end the call, press the  key or hang up the handset.

Calling in hands-free mode

1. Without picking up the handset, dial the number using the alphanumeric keypad and press the  key to make the call. The  indicator will light up green indicating that the hands-free mode is active.
2. During an active call, press the  key to initiate the hands-free mode and confirm it with the lit indicator . Press the  key again to turn off the hands-free mode.
Note: If the handset is hung up, pressing the key , again will end up the call.
3. To end the call, press the  key or hang up the handset.

Answer or silence an incoming call

1. During an incoming call, pick up the handset or press the  key to answer the call.
2. Before answering the call, you can mute the incoming call ring by pressing the  key.
3. When the call is active, press the  key to mute your microphone.
4. To reject an incoming call, press the  key.

Calling

Adjusting the volume

During an active call, press the [🔊] [🔊] keys to reduce or increase the headset or the hands-free volume.





Calling from call log

1. In standby mode, press [OK] or press the left softkey to access the applications menu, then select the  icon to access the call log.
2. Use the arrow keys [◀][▶] to show on the screen the list of outgoing, incoming or missed calls. Use the [▲][▼] keys to move up and down the list, select a call and press the [📞] key to place the call.
3. To end the call, press the [📞] key or hang up the handset.



Calling from phonebook

1. In standby mode, press [OK] or press the left softkey to access the applications menu, then select the  icon to see the phone's contacts list.
2. Use the [▲][▼] keys to move up and down the contacts list and select the one you want.
3. Once selected, press the [📞] key to place the call.
4. To end the call, press the [📞] key or hang up the handset.

Transfer an incoming call

1. During an incoming call, pick up the handset or press the  key to answer the call.
2. Press the  key to pause the incoming call and initiate a second call to another phone number or to a contact from the phonebook, or press [Options](#) and select [Add Call](#) from the pop-up menu.
3. When the second call is active, press the  key to transfer the first call to the second contact, or press the  key before the second call is active to make cold transfer “without consultation”.

Three way calling

1. During an incoming call, pick up the handset or press the  key to answer the call.
2. Press the  key to pause the incoming call and initiate a second call to another phone number or to a contact from the phonebook.
3. When the second call is active, press the  key, or press [Options](#) and select [Merge calls](#) in the pop-up menu to initiate the conference call.
4. Repeat the procedure to add up to 5 participants.

Calling with speed dial keys

1. In standby more, press one of the memory keys [**M1-M4**], or maintain pressed one of the keys of the numeric keyboard [**1...9**] to use speed dial. The call will proceed automatically.
2. To end the call, press the  key or hang up the handset.

Calling

Configuring speed dial keys

1. Access the menu, select the  icon and press [OK] to access the calls menu.
2. Press **Options** and **Speed Dial** in the pop-up menu.
3. Select one of the memory keys **M1 - M4**, or **2 - 9** to edit its contents.
4. You can associate a phone number of a phonebook contact to the speed dial [**M1-M4**] keys and to the [**1...9**] keys.
5. Select **Add** to confirm and finish the operation.

Note:

Please, make sure the speed dial keys have received a configuration before using them. The [1] key is reserved for the voicemail function.

Calling the voicemail

1. In standby mode, maintain pressed the [1] key to call the voicemail. The call will begin automatically.
2. To end the call, press the [] key or hang up the handset.

The Co-Comm F740 terminal support SMS text and MMS multimedia messages. This section explains how to send and receive messages, and other related features.

Create and send messages

1. Access the applications menu, select the  icon and press [OK] to launch the messages application
2. Press [Write new message](#) in the main screen or press [Options](#) and select [New Message](#) in the pop-up menu.
3. Introduce a phone number or the name of the contact to which you want to send the message. Press the [#] key to switch between uppercase letters, lowercase letters and numbers, or use the [*] key to introduce special characters.
4. Write the text in the indicated field. If you want to add multimedia files to the message, press [Options](#) then press [OK] on [Attach](#) in the pop-up menu.
5. Press [Options](#) then press [OK] on [Send](#) to send the message.

View and reply to messages

1. Access the applications menu, select the  icon and press [OK] to launch the messages application.
2. Select one of the messages in the list and press [OK] to view it.
3. To respond to the message, write the text in the indicated field. If you want to add multimedia files to the message, press [Options](#) then press [OK] on [Attach](#) in the pop-up menu.
4. Press [Options](#) then [OK] on [Send](#) to send the message.

Messages

Delete messages

1. Access the applications menu, select the  icon and press [**OK**] to launch the messages application.
2. Select one of the messages in the list and press [**OK**] to view it.
3. Use the arrow keys [**▲**] [**▼**] to select the message.
4. Press **Options** then [**OK**] on **Delete** to delete the message from the inbox.
5. Select **Delete** in the confirmation window to finish the operation and delete the desired message.

Empty inbox

1. Access the applications menu, select the  and press [**OK**] to launch the messages application.
2. Press **Options** then [**OK**] on **Delete all threads** in the pop-up menu.
3. Select **Delete** in the confirmation window to finish the operation and delete all messages from the inbox.

Message settings

1. Access the applications menu, select the  icon and press [**OK**] to launch the messages application.
2. Press **Options** then [**OK**] on **Settings** in the pop-up menu. You will be able to define the following settings:
 - **SMS Enabled**: allows you to change the predetermined SMS application.
 - **Texte Messages (SMS)**: press to access all the text messages settings:

- **Request delivery report:** enable this option to request a delivery confirmation every time a message is sent.
- **Manage SIM card messages:** use this option to delete messages and check the free and used space on the SIM card.
- **Edit quick text:** this option allows you to add quick texts to automatically insert in your messages.
- **SMS Service Center:** network operator's messaging server, this field should not be modified.
- **SMS storage location:** allows you to choose between the SIM card or the phone memory to store the messages.
- **Optimization:** enable this function to send messages in optimized mode (GSM 7 bits), or deactivate it if you want tildes and other special characters to be shown in your text messages (Unicode UCS2).
- **Multimedia Messages (MMS):** press to access multimedia messages settings:
 - **Group messaging:** use this option to send a message to multiple recipients using MMS.
 - **Request delivery report:** enable this option to receive a delivery confirmation when you send a message.
 - **Read read report:** enable this option to receive a delivery confirmation when you send a message.
 - **Send read report:** enable this option to send a read message confirmation when required by the sender.
 - **Auto-retrieve:** use this option to download messages automatically.

Messages

- **Roaming auto-retrieve:** use this option to automatically retrieve when you are in roaming data mode.
- **Size Limit:** allows you to select a maximal size for the MMS messages.
- **Notifications:** press to access to the message notification settings:
 - **Message notifications:** enable or disable message notifications.
 - **Mute:** use this option to temporarily mute message notifications.
 - **Sound:** select notification tone for messages.
 - **Pop-up notification:** shows pop-up notifications for push messages. Push messages are notifications that a server sends to an application alerting it that it has new information, such as an email or a chat message, for example.
- **General:** press to access to the general configuration of the messages:
 - **Message font size:** select the font size for your conversations.
 - **Storage settings:** allows to set a limit of messages stored, after which the oldest messages will be automatically deleted.
 - **Cell broadcast settings:** allows you to enable cell broadcast from the SIM card.

This section explains how to create and manage your phonebook contacts.

Creating a new contact

1. In standby mode, use the alphanumeric keypad to enter the number of a new contact.
2. Press **Options** and select **Add Contacts** in the pop-up menu.
3. Select where the contact will be saved (SIM card, phone, etc.).
4. Fill in the form with the information you want to enter for the new contact, press **Options** and select **Save** to save the entry and finish the operation.

Creating a new contact from call log

1. Access the applications menu, then select the  and press [**OK**] to access the call log.
2. Use the arrow keys [**◀**][**▶**] direction keys to display the outgoing, incoming and missed calls, and use the [**▲**][**▼**] keys to select one call then press [**OK**] to access the entry.
3. Press **Options** and select **Add to contacts**, then select where the contact will be saved (SIM card, phone, etc.).
4. Fill in the form with the information you want to enter for the new contact, press **Options** and select **Save** to save the entry and finish the operation.

Contacts

Import/Export contacts

1. Access the applications menu, select the  and press [**OK**] to access the contacts menu.
2. Press **Options** and select **Import/Export** in the pop-up menu.
3. Select the origin from where you want to copy those contacts (SIM card, phone, internal memory, etc.).
4. Select the destination where you want to copy those contacts.
5. Select the contacts you want to copy, or press **Options** then **Select All** to select all the contacts from the source, then press **Accept** to finish the process.

Import contacts from an SD Card

1. Access the applications menu, select the  icon and press [**OK**] to access the contacts menu.
2. Press **Options** and select **Import/Export** in the pop-up menu. Then, select **Import**.
3. Select the origin from where you want to copy the contacts, in this case the SD card.
4. Select the destination where you want to copy the contacts, in this case the **Phone**.
5. The contacts will be merged in the phonebook.

Note:

In the case where there are many vcf (or vcard) files on the SD card, a message will appear from which you will be able to select one, many or all of them.

Import contacts through Bluetooth

1. For this, you need to enable Bluetooth both on your Co-Comm F740 terminal and on your smartphone, and pair them.
2. Once they are paired, access to the [Contacts](#) on your smartphone and select [Share](#) or [Export](#) (will depend on the phone you are using), select the option [Share via Bluetooth](#), and then select the contacts you want to send (you can select [All Contacts](#)).
3. On your Co-Comm F740 terminal will appear a message to confirm the transfer of the files. Use the arrow keys [▲][▼] to select [Accept](#) and press [OK].
4. Once the contacts are sent, access the [Settings](#)> [Connected Devices](#)> [Bluetooth](#) menu, as explained below in the [Pairing to a Bluetooth® device](#) section.
5. Use the [▲][▼] keys to select [Received files](#) and press [OK]. You will see the vcf (or vcard) file received, press [OK] on it.
6. A message will appear to confirm the importation of the contact. Then, use the [▲][▼] direction keys to select [Accept](#) and press [OK]. The contacts will be imported into the device's phonebook.

Contacts

Edit Contacts

1. Access the applications menu, select the  and press [**OK**] to access the contacts menu.
2. Use the [**▲**] [**▼**] keys to select a contact and press [**OK**] to access it.
3. Press **Options** and select **Edit** in the pop-up menu.
4. Fill in the form with the information you want to enter for the new contact, press **Options** and select **Save** to save the entry and finish the operation.

Delete contact

1. Access the applications menu, select the  and press [**OK**] to access the contacts menu.
2. Use the [**▲**] [**▼**] keys to select a contact and press [**OK**] to access it.
3. Press **Options** and select **Delete** in the pop-up menu.
4. Select **Delete** in the confirmation window to delete the contact.

Bluetooth® connection

The Bluetooth® function allows you to pair your terminal with other Bluetooth devices, to perform certain actions.

- Connect various Bluetooth accessories like, for example, Bluetooth headphones to answer calls received by the terminal.
- Exchange contacts and audio, video or photo files with other devices.

Pairing to a Bluetooth® device



1. Select the  icon within the applications menu and press [**OK**] to access the parameters menu. Use the [**▲**] [**▼**] keys to select **Connected Devices**, use the direction keys [**▲**] [**▼**] again to select **Bluetooth** and [**OK**] to activate the Bluetooth function.
2. Make sure you have temporary visibility on both devices
3. Press [**OK**] on **Pair new devices**, and the devices located within reach of the terminal will be displayed on the screen.
4. Press [**OK**] on the device you want to pair with your terminal, and accept the request on the pop-up window on both devices.
5. You can modify the name of the device with the **Device Name** option or look at the files exchanged in the **Received Files**.

When the Bluetooth function is active,  the icon will be visible in the notification bar. When the device is paired with our terminal, the icon will change to  in the notification bar.

To deactivate the Bluetooth function, go to the **Connected Devices** menu, and press [**OK**] on **Bluetooth**, use the [**▲**] [**▼**] arrow keys and press [**OK**] on **ON**. The Bluetooth function will disconnect automatically.

Troubleshooting

Phone can not be turned on

- Be sure to hold down the [] button for more than 5 seconds.
- Make sure battery is properly connected to your phone.
-  Remove the battery, reinstall it and restart your phone.
-  If the battery is low, recharge it.

Phone asks for PIN code

- PIN lock feature is enabled. Each time the phone is switched on, PIN must be entered (if you are using your phone for the first time, you must enter the PIN code provided with SIM card).



Phone asks for PUK code

- PIN code has been entered incorrectly three times, and now SIM card is locked. Enter PUK code provided by your network operator.

Phone asks for unlock code

- The automatic locking function has been enabled in the phone. You must enter unlock code before you can use your phone.

SIM card error

- Clean metal contacts on the SIM card with a clean cloth (do not use a solvent).
-  SIM card is not properly placed. Insert SIM card according to the unit figure.
-  If the SIM card is damaged, contact your network provider.

Network failure

- It is possible that the phone is located in a weak signal area, move to a place with a stronger signal.

It is out of network service coverage

- SIM card is not valid, contact your network provider.

You have entered a number but the phone is not calling

- Make sure you have correctly pressed the button.
- Check call barring options. Verify that barring is disabled for contact number.
- Check the fixed dialing setting is disabled.
- Check that the SIM card is within network coverage.
- Our network operator may be experiencing connection problems.

Call quality is poor

- Check the volume.
- Is in a weak signal area, such as near tall buildings or in a basement. Move to a location with better signal strength.
- Our network operator may be experiencing connection problems.

Your correspondent can not call you

- Make sure the phone is turned on and connected to a network.
- Make sure SIM card is not locked.
- Check that SIM card is within network coverage.
- Check that you have not set an incoming call barring.

Troubleshooting

Your correspondent can not hear you

- Increase handset volume.
- Check that handset cable is securely connected to the phone.

Battery duration in standby mode is too short

- Battery standby duration is related to network configuration. You may be in a weak signal area. If the phone can not receive signals, it will keep sending a signal to search network and consume additional power, which shortens battery duration.

Battery needs to be changed

- If the battery cannot charge properly.
- Make sure power cord is properly connected to efficiently charge.
- Clean charging contact from the device and battery with a clean, dry cloth.
- Replace the battery or charger if it seems to be damaged.

If the above guidelines do not help in solving the problem, note model and serial numbers of your phone, your warranty details and a clear description of the problem. Then contact with your after-sales service provider.

Through this, CO-COMM Servicios Telecomunicaciones S.L. declares that this product meets the essential requirements and other relevant provisions of Directive 2014/53/EU (RED), of the European Parliament and the Council of April 16, 2014.

You can obtain a copy of the declaration of conformity with the directive mentioned by sending an email to clientes@cocomm.es, adding the word DoC in the Subject line, and specifying the lot number of the product in the body of the message. This product can be used in all EU countries (and other countries following the 2014/53/EU directive).



ErP product information

Through this, CO-COMM Servicios Telecomunicaciones S.L. declares that this product complies with Directive 2009/125/EC and its implementing regulation (EC) N°1275/2008 amended by (EC)N°278/2009, (EC)N°642/2009, (EU)N°617/2013, (EU) N°801/2013, and its implementing regulation (EC) N°278/2009.

Energy consumption of the product, connected to network, in standby, and with all its physical and wireless interfaces connected, is 0.132 W.

With regards to information required by the regulations (EU) N°801/2013 that appears on websites free access for manufacturers, visit <http://www.cocomm.es>.

Regulation

SAR certification information

This mobile device meets guidelines for exposure to radio waves.

It is a radio transmitter and receiver low power. It is designed not to exceed the limits for exposure to radio waves as recommended by international guidelines.

These guidelines were established by the International Commission on Non-Ionizing Radiation (ICNIRP), which is an independent scientific organization, and include safety measures designed to ensure the protection of persons, regardless of age or health status.

Specific Absorption Rate (SAR) is the unit of measurement for the absorbed radio amount when using mobile devices. SAR tests are conducted in standard operating positions with the phone transmitting at its highest certified power level, however, actual SAR level of the phone while operating can be well below maximum value. In general, the closer you are to a base station, the lower phone power is being reduced. SAR values may vary, depending on the phone being used. To ensure safety and health of users, phone is designed and manufactured to meet radio exposure guidelines.

Recommended SAR limit by the Council of the European Union for mobile devices used by the general public is 2 W/kg and the highest SAR value for this device, which was tested for use at the ear is for SAR below the recommended limit.

Highest SAR value found during product certification is 0.969 W/kg, averaged over 10g of tissue, measured on WCDMA I band.



This product complied with Directives 2012/19/EU (WEEE Directive) and 2011/65/EU (RoHS2 Directive) and Regulation (EC) N°1907/2006 (REACH), and bears selective sorting symbol for waste electrical and electronic equipment (WEEE). This means that this product must be handled pursuant to European Directive

2002/96/EC in order to be recycled or dismantled to minimize its impact on the environment. For further information, please contact your local or regional authorities. Electronic products not included within selective sorting process are potentially dangerous for the environment and human health due to presence of hazardous substances.

Final product price is including the environmental management cost of the electronic residues, as it is established legally in the R.D. 208/2005.



Bluetooth® mark and logos are owned by Bluetooth SIG, Inc.

All other trademarks, products, services and company names mentioned herein belong to their respective owners.

Copyright © CO-COMM Servicios Telecomunicaciones S.L. 2020. All rights reserved. CO-COMM Servicios Telecomunicaciones S.L. reserves the right to change or modify any information or specifications contained in this manual without previous notice.



Copyright © CO-COMM
Servicios Telecomunicaciones S.L. 2020
All right reserved